



Time Out

MARKET

MIAMI BEACH

1601 DREXEL AVENUE :: MIAMI BEACH, FL 33139

SHEET INDEX:

PLANNING BOARD

| | |
|------|----------------------------------|
| A-00 | COVER PAGE |
| A-01 | SITE |
| A-02 | SITE DATA |
| A-03 | FAR CALCULATIONS |
| A-04 | EXTERIOR BUILDING PHOTOS |
| A-05 | EXTERIOR BUILDING PHOTOS |
| A-06 | EXTERIOR BUILDING PHOTOS |
| A-07 | EXTERIOR BUILDING PHOTOS |
| A-08 | INTERIOR BUILDING PHOTOS |
| A-09 | INTERIOR BUILDING PHOTOS |
| A-10 | EXISTING USE PLAN |
| A-11 | EXISTING GROUND LEVEL PLAN |
| A-12 | EXISTING ROOF PLAN |
| A-13 | DEMOLITION PLAN |
| A-14 | EXISTING/DEMO ELEVATIONS |
| A-15 | GROUND LEVEL PLAN |
| A-16 | REFLECTED CEILING PLAN |
| A-17 | SECTIONS |
| A-18 | WEST & SOUTH ELEVATION |
| A-19 | STOREFRONT SECTION |
| A-20 | DELIVERY & WASTE MANAGEMENT PLAN |
| A-21 | EXTERIOR AWNING AND BLADE SIGN |
| A-22 | PRIMARY EXTERIOR SIGNAGE |
| A-23 | KIOSK RENDERED ELEVATION |
| A-24 | KIOSK ISOMETRIC RENDERING |
| A-25 | KIOSK ISOMETRIC RENDERING |
| A-26 | POP-UP BAR ISOMETRIC RENDERING |
| A-27 | COMMUNAL TABLE SEATING RENDERING |
| A-28 | OPERABLE STOREFRONT SECTION |
| A-29 | OPERABLE STOREFRONT ELEVATION |
| A-30 | HYDRAULIC BI-FOLD SYSTEM |
| A-31 | HYDRAULIC BI-FOLD SYSTEM |

SCOPE OF WORK :

- EXISTING BUILDING INTERIOR BUILD-OUT
- 16,150 SQ FT FOOD HALL

REVISIONS

| No. | DESCRIPTION | DATE |
|-----|-------------|------|
| | | |
| | | |
| | | |

SUBMITTAL: HISTORICAL PRESERVATION BOARD

1st SUBMITTAL: NOVEMBER 29, 2016

Final SUBMITTAL: DECEMBER 15, 2016

COVER PAGE

A-00

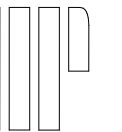

SKETCH OF BOUNDARY SURVEY ALTA/ACSM LAND TITLE SURVEY

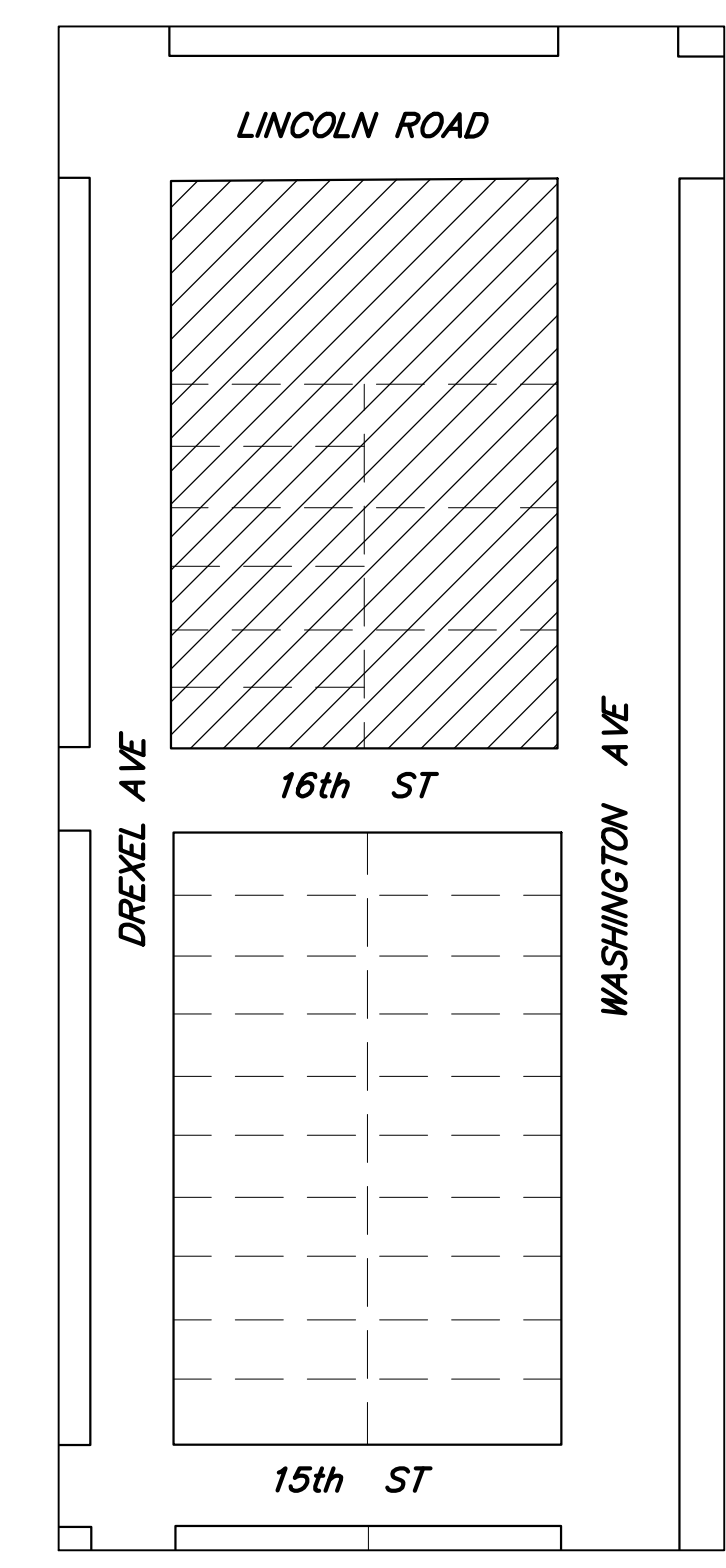
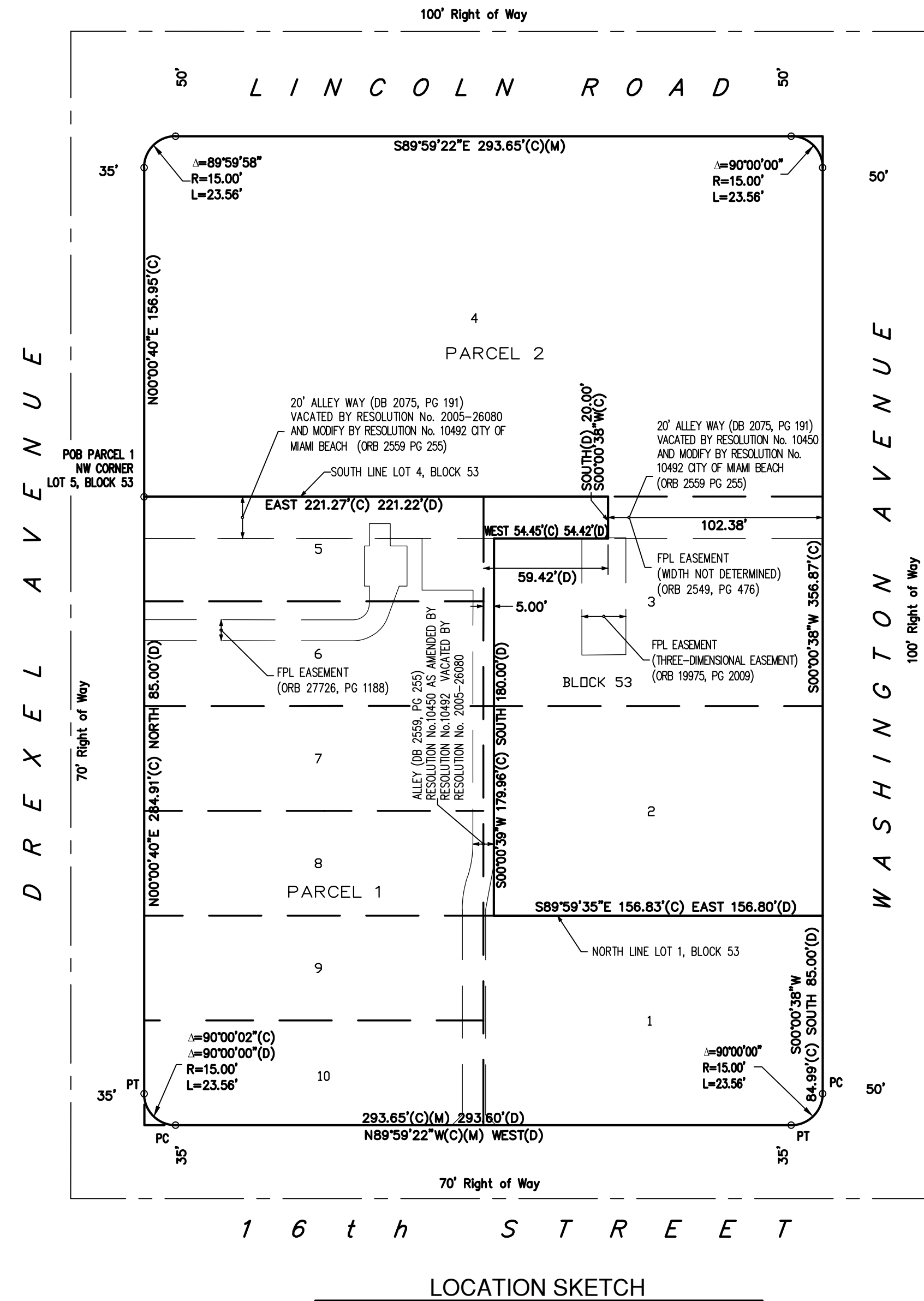

VICINITY MAP
Not to Scale
A Portion of Section 34, Township 53 South, Range 42 East
Miami-Dade County, Florida

LEGAL DESCRIPTION:

PARCEL 1:
Lots 1, 5, 6, 7, 8, 9 and 10 inclusive, Block 53 Pine Ridge Subdivision, a subdivision recorded in Plat Book 6 at Page 34 of the Public Records of Miami-Dade County, Florida; ALSO the West 5.0 feet of Lots 2 and 3; AND ALSO, the portion of the Alley recorded in Deed Book 2075 at Page 191 of the aforementioned subdivision; LESS the Alley recorded in Official Record Book 2559 at Page 255; more particularly described as follows:

Begin at the Northwest corner of Lot 5, Block 53; thence run East along the South line of Lot 4, for a distance of 221.22 feet; thence run South (along a line 102.38 feet West of and parallel with the East line of Lot 3) for a distance of 20.00 feet; thence run West along (a line parallel with) the North line of Lot 3, for a distance of 54.42 feet; thence run South along a line 5.0 feet East of and parallel to the West line of Lots 2 and 3, for a distance of 180.00 feet; thence run East along the North line of Lot 1, for a distance of 156.80 feet; thence run South along the West right of way line of Washington Avenue, for a distance of 85.00 feet to a point of curvature of a curve concave to the Southwest having for its elements a radius of 15.00 feet and a central angle of 90°00'00"; thence Southwesterly along the arc a distance of 23.56 feet to a point of tangency; thence run West along the North Right of Way Line 16th Street, for a distance of 293.60 feet to a point of curvature of a curve concave to the Northwest having for its elements a radius of 15.00 feet and a central angle of 90°00'00"; thence Northwesterly along the arc a distance of 23.56 feet to a point of tangency; thence run North along the East Right of Way Line Drexel Avenue, for a distance of 285.00 feet to the Point of Beginning.

Together with those certain North-South and East-West alleyways described in that certain QUIT CLAIM DEED, dated March 15, 2016 and recorded March 23, 2016 in Official Records Book 30009, Page 4775, of the Public Records of Miami-Dade County, Florida.

PARCEL 2:
Lots 2, 3 and 4, Block 53, of Pine Ridge Subdivision, a subdivision recorded in Plat Book 6, Page 34, of the Public Records of Miami-Dade County, Florida; LESS the West 5.0 feet of Lots 2 and 3 and ALSO LESS that the portion of the North 20 feet of Lot 3, which lies West of a line 102.38 feet West of and parallel with the East line of Lot 3.

SURVEYOR'S NOTES:

Bearings are based on an assumed meridian, where the South line of Lot 4, Block 53, of said Pine Ridge Subdivision, bears East. All distances as shown are based on the US Survey foot.

Elevations are referred to the National Geodetic Vertical Datum, (NGVD 1929). Elevations are based on Miami-Dade County Benchmark D-149, the same being a PK nail and brass washer set in a concrete gutter at Southwest corner of intersection, located at 37 feet South of the centerline of NE 15th Street and 32 feet West of the centerline of Meridian Avenue, elevation 4.18 feet.

The accuracy obtained for all horizontal control measurements and office calculations of closed geometric figures, meets or exceeds the Standards of Practice as set forth by the Florida Board of Professional Surveyors and Mappers as contained in Chapter 5J-17.05(1)(b)15.b.i) FAC of 1 foot in 10,000 feet for Commercial Areas. The elevations as shown are based on a closed level loop to the benchmark noted above, and meets or exceeds the Standards of Practice as set forth by the Florida Board of Professional Surveyors and Mappers as contained in Chapter 5J-17.05(1)(b)15.a) FAC, of a closure in feet of plus or minus 0.05 feet times the square root of the distance in miles.

The Surveyed Parcel represents a survey of Lots 1, 2, 3, 4, 5, 6, 7, 8, 9 and 10, Block 53, of the said plat of PINE RIDGE SUBDIVISION, the same being Parcel 1 and Parcel 2 when taken together, including the alleys dedicated in Deed Book 2075 at Page 191 and Official Record Book 2559 at Page 255. (Pursuant to Miami Beach, Florida, Resolution No. 2005-26080 the alleyways were vacated and deed by QUIT CLAIM DEED, recorded in Official Records Book 30009, Page 4775.)

This SKETCH OF BOUNDARY SURVEY of the surveyed parcel is based on: (i) recovered monumentation and (ii) the underlying record plat of PINE RIDGE SUBDIVISION, recorded in Plat Book 6 at Page 34.

Any notorious evidence of occupation and/or use of the described parcel for Right-of-Way, Ingress or Egress are shown on this survey drawing. However, this survey does not purport to reflect any recorded instruments or Right-of-Way other than as shown on the underlying record plat or as stated in the legal description or as noted in the recorded documents provided to the Surveyor.

A comparison between measured and platted dimensions is delineated hereon. Measured dimensions (M) are based directly on the recovered monumentation. Platted dimensions (P) are based on the aforementioned plat of PINE RIDGE SUBDIVISION.

The Subject Property does lie within a Special Flood Hazard Area (SFHA) as shown on the National Flood Insurance Programs, Flood Insurance Rate Map for Miami-Dade County, Florida and Incorporated Areas Map No. 12089C0317L, Community No. 120651, bearing an effective/revision date of September 11, 2009. Said map delineates the herein described land to be situated within Zone AE, base flood elevation 8 feet.

The area of Parcel 1, as described herein including the area of the excluded alleys referenced therein, contains 66,708 square feet more or less (1.53 Acres more or less). The area of Parcel 2, as described herein, contains 85,817 square feet more or less (1.97 Acres more or less). The total area of the Surveyed Parcel as described herein contains 152,525 square feet more or less (3.50 Acres more or less).

There are 479 standard parking spaces and 10 handicap parking spaces in the Parking Garage for a total of 489 parking spaces. (Based on May 18, 2015 survey, as last revised July 15, 2015)

SURVEYOR'S NOTES: (Cont...)

Only the surface indications of the underground utilities have been located in the field. The location of underground utility lines on or adjacent to the property was not secured. The Surveyor has performed no subsurface investigation or determined the location of underground footers. It should be noted that there may be other underground utilities in addition to those evidenced by visible appurtenances shown on this sketch. The owner or his agent should verify all utility locations with the appropriate utility provider before using.

There are no adjoining owners based on the web based the Miami-Dade County Property Appraiser's Property Search Summary Report.

There is no observable evidence of earth moving work, building construction or building additions within recent months.

There is no observable evidence of the site being used as a solid waste dump, sump or sanitary landfill.

There is no evidence of proposed changes in right of way made known to the Surveyor. There is no observable evidence of recent street or sidewalk construction or repairs.

There is no observable evidence that any portion of site lies within a wetland area, nor was there any evidence provided to the surveyor that the site was delineated as a wetland area by the appropriate authorities.

The easements, encumbrances and restrictions evidenced by Recorded Documents and/or other title exceptions provided to the surveyor as noted in Schedule B.II, of the First American Title Insurance Company, Commitment for Title Insurance, File Number 1062-3334506, with an effective date of March 24, 2015, as to the extent they can be located are shown hereon or otherwise noted as to their effect on the Property as follows:

- Item 9) There is no roadway dedication statement, easements or setback restrictions shown or noted on the face of the plat of PINE RIDGE SUBDIVISION, as recorded in Plat Book 6 at Page 34. The aforementioned plat does not disclose any other plottable matters affecting the subject property.
- Item 10) The lands subject to the lease, described in Exhibit "B" to the Short Form Lease, recorded in Official Records Book 21009, Page 2950, lies wholly within the Surveyed Parcel as described herein. The depiction of the location of the retail space in Exhibit "D" to said Lease lies within Parcel 2 as described herein. The effect of the lease on the subject property is not a survey issue and lies outside of the scope of this survey.
- Item 11) The East-West alleyway recorded in Deed Book 2075, Page 191 as evidenced in City of Miami Beach Resolution No. 10450 together with the vacation of the East 102.38 feet of the said East-West alleyway and the dedication of the North-South alleyway as modified by Resolution No. 10492 is plotted hereon. (City of Miami Beach Resolutions are available on the City of Miami Beach Official Website -

SURVEYOR'S NOTES: (Cont...)

www.miamibeachfl.gov, via WebLink). Said alleys as modified are the excluded alleyways described in Parcel 1.

Item 12) The North-South alleyway recorded in Official Record Book 2559 at Page 255, is one and the same as the North-South alleyway evidenced in City of Miami Beach Resolution No. 10450 as modified by Resolution No. 10492, said alleyway is plotted hereon and lies wholly within Parcel 1.

Item 13) The easement in favor of Florida Power & Light Company, for an underground duct bank and cables and the right of ingress and egress, described in that certain Document, recorded in Official Records Book 2549, Page 476 lie within the East 102.38 feet of the North 20 feet of Lot 3, Block 53 of said PINE RIDGE SUBDIVISION, the said area is plotted hereon and lies within Parcel 2. Noting however, the specific easement width and vertical limits are not defined. The underground duct bank and cables run under the entire length of the suspended floor slab of the portion of the building over the aforementioned strip of land with an excavated space above the duct bank to permit access in case of future failures to the duct bank, not visible to the Surveyor.

Item 14) The easement, described in that certain Document, recorded in Official Records Book 19975, Page 2009 lie within Parcel 2 and is plotted hereon. Said easement is a "three-dimensional easement" with a height limitation of 12 feet, however the base reference is not noted.

Item 15) The easement, described in the Underground Easement, recorded in Official Records Book 27726, Page 1188 lie within Parcel 1 between elevation (-) 4.0 feet and elevation 17.0 feet, relative to the National Geodetic Vertical Datum and is plotted hereon.

Item 16) The lands described in Exhibit "A" to the Notice of Landlord, recorded in Official Records Book 24315, Page 835, lie wholly within the Surveyed Parcel as described herein. The effect of the Notice on the subject property is not a survey issue and lies outside of the scope of this survey.

Item 17) The lands described in Exhibit "A" to the Memorandum of Lease, recorded in Official Records Book 13728, Page 2475, being a portion of Lot 4 of approximately 4,600 square feet of ground floor space, lie wholly within the Surveyed Parcel as described herein. The description of the exclusive easement for the installation and maintenance of a sign on the exterior of the leased premises is vague and cannot be plotted. The effect of the memorialized lease on the subject property is not a survey issue and lies outside of the scope of this survey.

Item 18) The description of the Exhibit "A" premises, the area subject to the lease, described in to the Non-Disturbance and Attornment Agreement, recorded in Official Records Book 13725, Page 898, was not included and/or attached to the recorded document. The lands subject to the mortgage, described in Exhibit "A" to the Purchase Money Wraparound Mortgage, recorded in Official Records Book 12391, Page 873, as evidenced in the aforementioned Non-Disturbance and Attornment Agreement, lie wholly within the Surveyed Parcel as described herein. The effect of the Non-Disturbance and Attornment Agreement on the subject property is not a survey issue and lies outside of the scope of this survey.

SURVEYOR'S NOTES: (Cont...)

Item 19) The lands subject to the Conditional Use Permits recorded in Official Records Book 22925, Page 619; Official Records Book 25230, Page 107; Official Records Book 25254, Page 1877; Official Records Book 26275, Page 3143; Official Records Book 27717, Page 3864; Official Records Book 27018, Page 2874 and Official Records Book 27763, Page 2546 all lie within the Surveyed Parcel as described herein. The effect of the Conditional Use Permits on the subject property is not a survey issue and lies outside of the scope of this survey.

Item 20) The lands subject to the Orders of the Board of Adjustment of the City of Miami Beach, Florida recorded in Official Records Book 13720, Page 2585; Official Records Book 14646, Page 3653; Official Records Book 20093, Page 603; Official Records Book 20651, Page 1310; Official Records Book 24340, Page 1336; Official Records Book 25802, Page 969 and Official Records Book 27927, Page 1555 all lie within the Surveyed Parcel as described herein. The effect of the Orders of the Board of Adjustment on the subject property is not a survey issue and lies outside of the scope of this survey.

Item 21) The lands subject to the Orders of the Historic Preservation Board of the City of Miami Beach, Florida recorded in Official Records Book 20521, Page 3108; Official Records Book 23473, Page 2991; Official Records Book 25327, Page 4458; Official Records Book 26191, Page 3243 and Official Records Book 26998, Page 801 all lie within the Surveyed Parcel as described herein. The effect of the Orders of the Historic Preservation Board on the subject property is not a survey issue and lies outside of the scope of this survey.

Item 22) The lands described in Exhibit "A" to the Declaration of Restrictive Covenants in Lieu of Unity of Title, recorded in Official Records Book 25018, Page 1153, are one and the same parcel of land as described in Parcel 1 as described herein. Said Declaration provides for the nonexclusive use of 175 parking spaces within the parking facility located within Parcel 1 during a specific time frame. The effect of the restrictions on the subject property is not a survey issue and lies outside of the scope of this survey.

NOTE: Pursuant to Resolution No. 2005-26080, made known to the Surveyor, the Mayor and the City Commission of the City of Miami Beach, Florida authorized the vacation the two remaining alleys within Block 53 (the East-West alley recorded in Deed Book 2075, Page 191 and the North-South alleyway recorded in Official Record Book 2559 at Page 255 as modified by City of Miami Beach Resolution No. 10450 and further modified by City of Miami Beach Resolution No. 10492 referenced under Items 11 and 12 above). Said remaining alleys were deemed to be the underlying property owners, pursuant to that certain QUIT CLAIM DEED, dated March 15, 2016 and recorded March 23, 2016 in Official Records Book 30009, Page 4775.

NOTE all recording references noted hereon, refer to the Public Records of Miami-Dade County, Florida, unless otherwise noted.

SURVEYOR'S CERTIFICATION:

To 420 Lincoln Road Associates, LTD, a Florida limited partnership and 420 Lincoln Road Development, LLC, a Florida limited liability company.

This is to certify that this map or plat and the survey on which it is based were made in accordance with the 2011 Minimum Standard Detail Requirements for ALTA/ACSM Land Title Surveys, jointly established and adopted by ALTA and NSPS, and includes Items 1, 3, 4, 7(a), 7(c), 8, 9, 11(a), 16, 17, 18, and 19 of Table A thereof. The field work was completed on May 18, 2015 and updated December 14, 2016. The undersigned further certifies that this map or plat meets the Standards of Practice, adopted by the Board of Professional Surveyors and Mappers, pursuant to Chapter 472.027 Florida Statutes, as set forth in Chapter 5J-17, Florida Administrative Code, under Sections 5J-17.051 and 5J-17.052 and is a "BOUNDARY SURVEY" as defined in Section 5J-17.050(10)(b).



E.R. Brownell & Associates, Inc.
SURVEYORS & MAPPERS
LAND PLANNERS
CONSULTING ENGINEERS
2434 SW 28th LANE
MIAMI BEACH, FLORIDA 33133
305-860-3866
WWW.ERBROWNELL.COM
Drawn by: J.B./AA Ref: Scale: 1"=50'
Checked by: I.B. Date: 02/23/2016
F.B. PLS/PSM No. 2891
Certification No. LB761

420 LINCOLN ROAD
MIAMI BEACH, FLORIDA

| No. | Date | Job No. | Description |
|-----|----------|---------|--|
| 1 | 6/29/15 | 57885-A | Revised Legal Description |
| 2 | 7/15/15 | 57885-A | Revised per Comments |
| 3 | 12/14/16 | 57885-E | Revised to update & revised legal description. |

Sheet: 1 OF 2
J.N. 57885 E
Sk. No.
LS-3187

C:\Pro\57885-C\420 Lincoln Rd. Miami Beach, FL. Altis Survey\57885-D_NEW_12-15-2016\57885-E_420 Lincoln Rd. Miami Beach, FL.dwg

SKETCH OF BOUNDARY SURVEY ALTA/ACSM LAND TITLE SURVEY

GRAPHIC SCALE

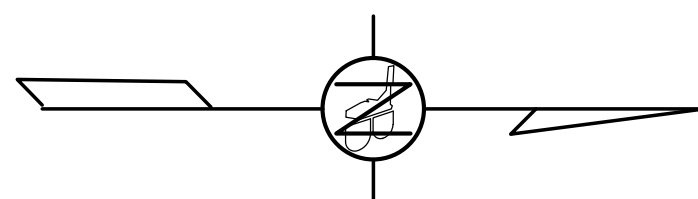
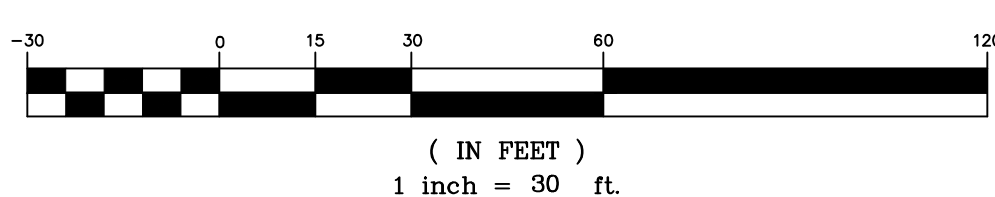

- ABBREVIATIONS:**
- PCP - Permanent Control Point
 - (P) - Plat Dimension
 - (M) - Measure Dimension based on recovered monumentation
 - (C) - Calculated Dimension based on recorded Plat
 - R/W - Right of Way
 - Δ - Delta Angle
 - R - Radius
 - L - Length
 - TB - Traffic Box
 - TBS - Traffic Signal Box
 - Set Nail & Disc* - Reset Nail & Disc based on field measurements of the recovered property corners.
 - P - Property Line
 - A/C - Air Condition

- SYMBOL LEGEND**
- Parking Pay Station
 - 🚲 Bike Path
 - ★ Light Pole
 - ☑ Catch Basin
 - ☐ Wire Pullbox
 - ⊙ Manhole Unmarked
 - ⊙ Electric Manhole
 - ⊙ Manhole Sanitary
 - Guard Post
 - ▬ Curb Inlet
 - ⊙ Double Detector Check Valve
 - Property Corner
 - Light Pole w/ Arm
 - Wood Pole
 - Centerline
 - Valve Water
 - Valve Gas
 - Meter Water
 - Single Support Sign

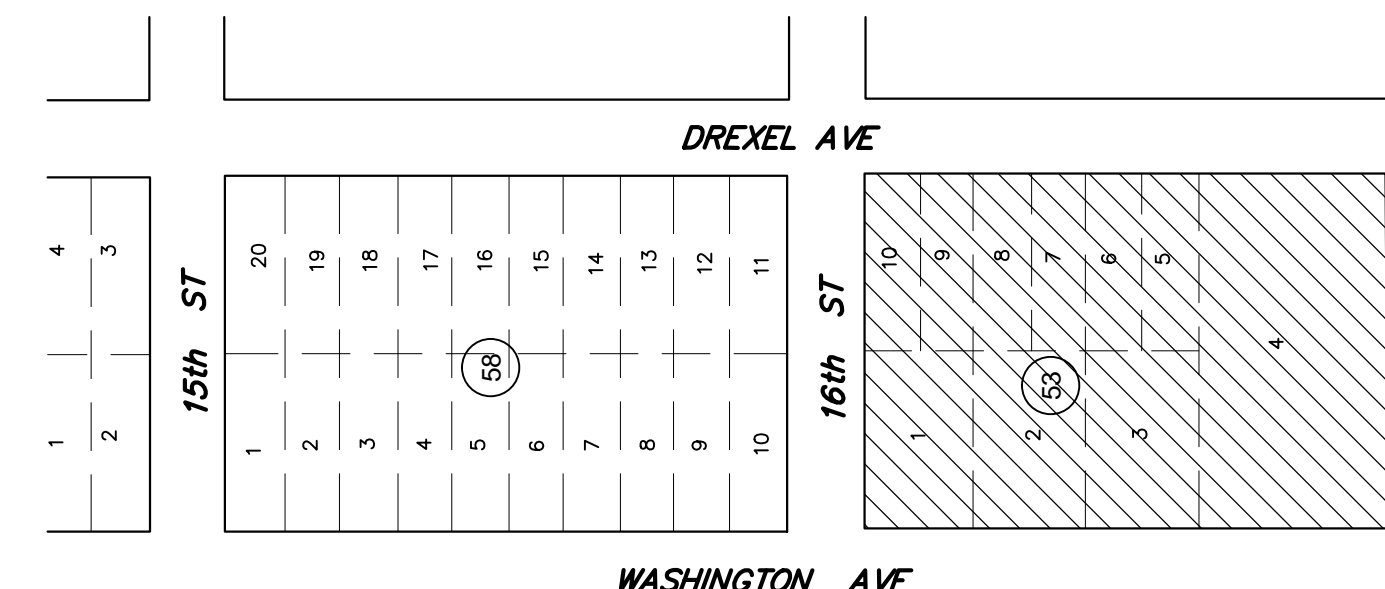
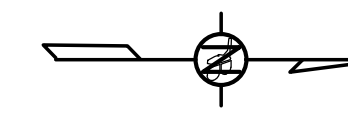
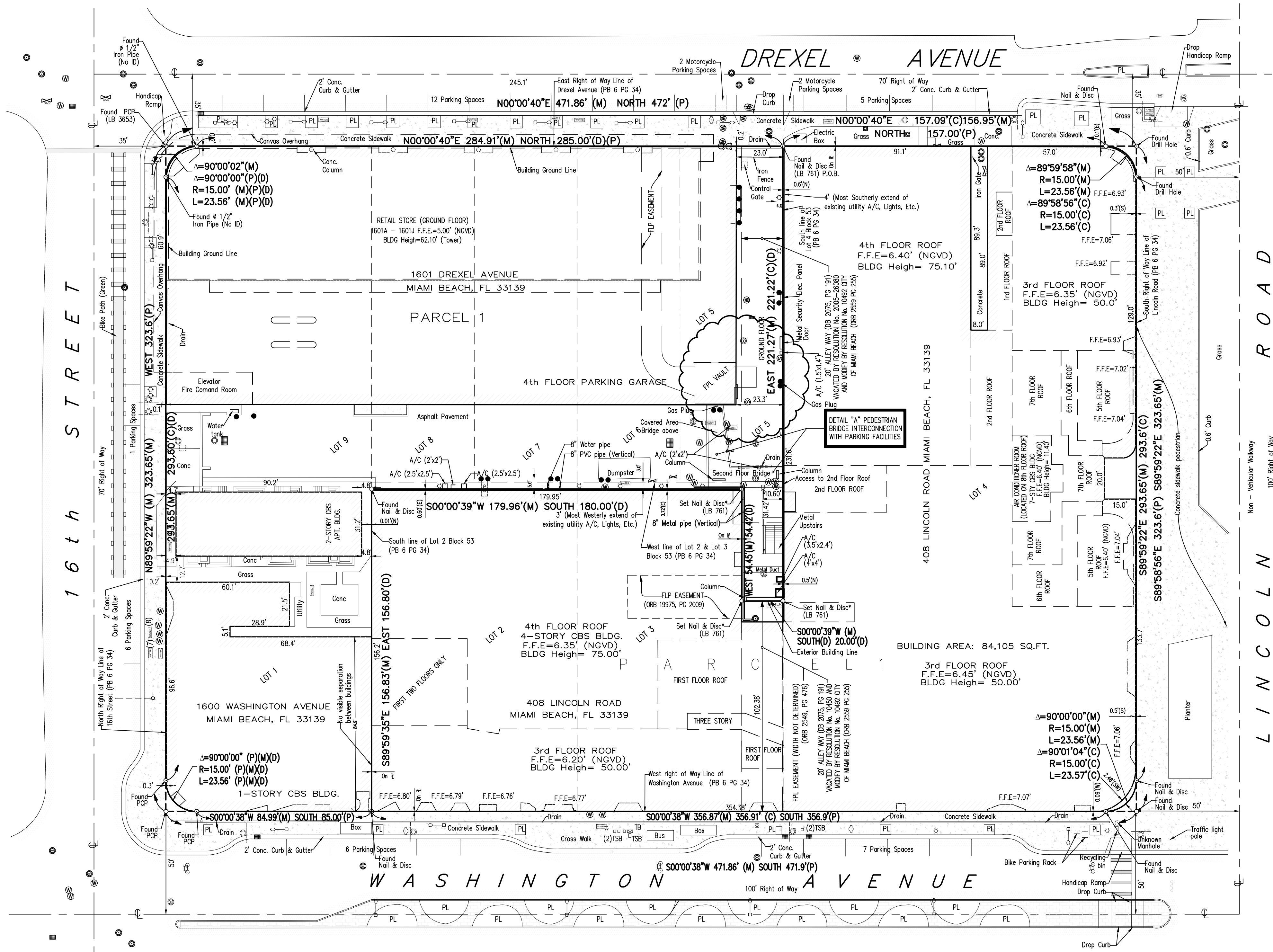

VICINITY MAP

Not to Scale

A Portion of Section 34, Township 53 South, Range 42 East
Miami-Dade County, Florida

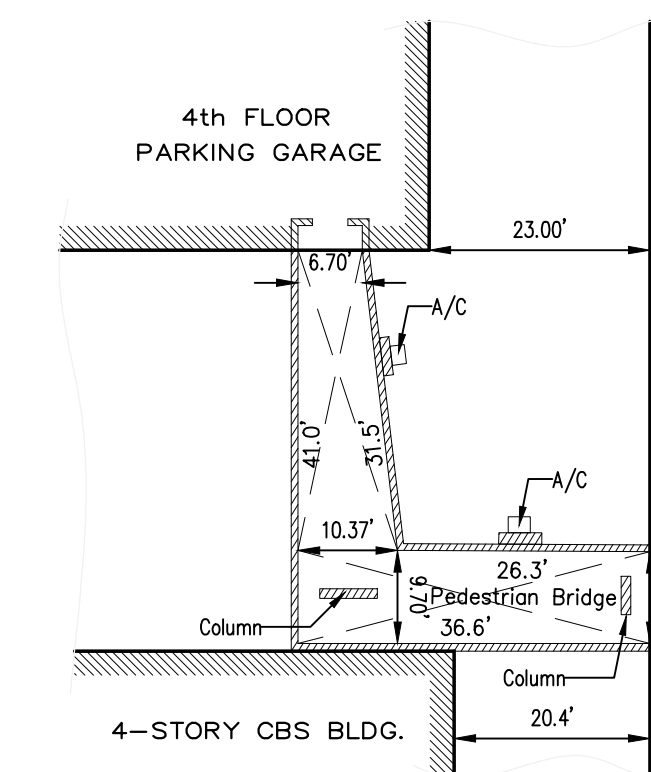

DETAIL "A"
TOP VIEW
Scale: 1"=20'

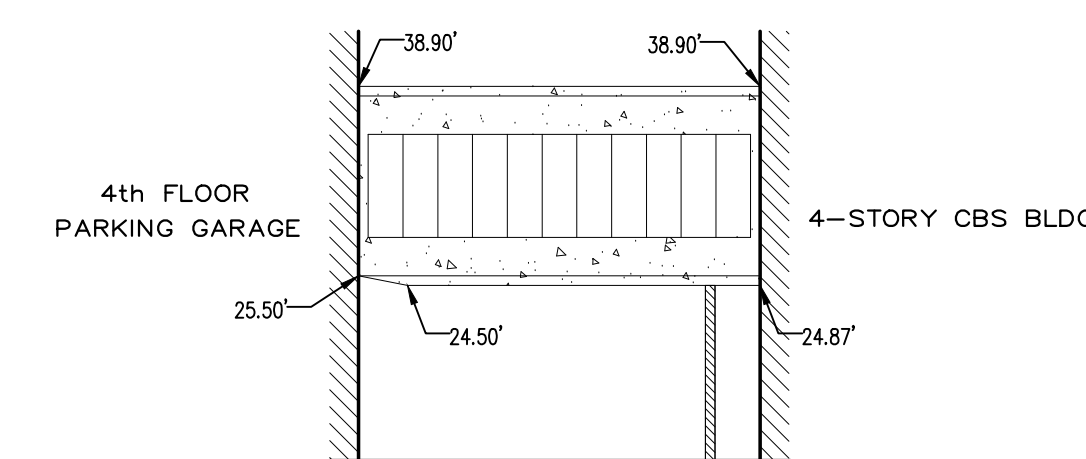

DETAIL "A"
LEFT SIDE VIEW
Scale: 1"=20'

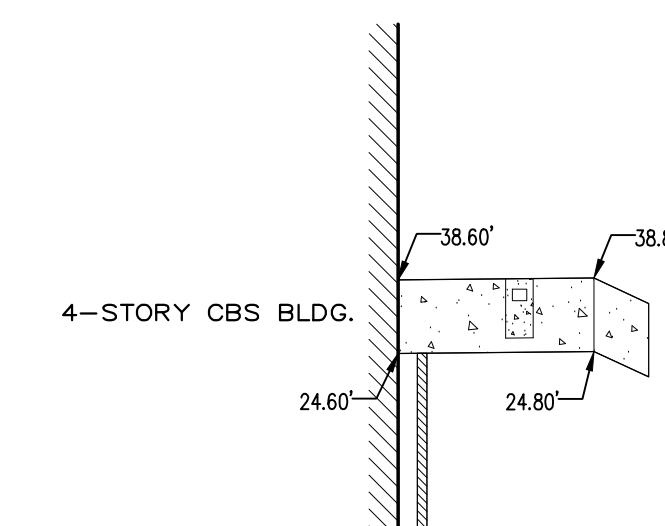

DETAIL "A"
FRONT VIEW
Scale: 1"=20'



E.R. Brownell & Associates, Inc.
SURVEYORS & MAPPERS
LAND PLANNERS
CONSULTING ENGINEERS
2434 SW 28th Lane
Miami, Florida, 33133
305-860-3870 (FAX)
305-860-3866
WWW.ERBROWNELL.COM
F.B. PLS/PSM No. 2891
Certification No. LB761

420 LINCOLN ROAD
MIAMI BEACH, FLORIDA
OWNER: 420 LINCOLN ROAD ASSOCIATES, LTD.
Drawn by: KAB/JB/AAP | Ref: Scale: 1"=30'
Chk. by: T.B.

| No. | Date | Apvd. | Job No. | Description |
|-----|----------|-------|---------|--|
| 1 | 6/29/15 | | 57885-A | Revised Legal Description |
| 2 | 7/15/15 | | 57885-A | Revised per Comments |
| 3 | 11/24/16 | | 57885-E | Revised to update & Revised Legal description. |

Sheet: 2 OF 2
J.N. 57885 E
Sk. No.
LS-3187



SOUNDSCAPE
PARK

LINCOLN ROAD

LINCOLN ROAD

420 BUILDING

PROJECT SITE
16,148 SF

LINCOLN LN S

PENNSYLVANIA AVE

DREXEL AVE

WASHINGTON AVE

16TH STREET

SITE PLAN



LEGAL DESCRIPTION

FOLIO: 02-3234-006-0040

PINE RIDGE SUB PB 6-34
LOT 5 LESS N20FT & ALL OF LOTS 6
THRU 10 BLK 53 LOT SIZE 45360 SQ FT

ZONING DATA

CODE OF CITY OF MIAMI BEACH

LOCATION 1601 DREXEL AVE

SITE DATA CRITERIA
ZONING DISTRICT CD-3 COMMERCIAL- HIGH INTENSITY

PARKING DATA (PARKING DISTRICT 2)

| PARKING CALCULATIONS | COUNT | REQUIRED | PROVIDED |
|-------------------------------------|------------------------------------|--------------------|-----------|
| RESTAURANT (INTERIOR) (EXTERIOR) | 16,148 SF - 320 SEATS 144 SEATS | 80 (1 PER 4 SEATS) | 87 |
| OFF-STREET | 12 EXISTING SPACES | N/A | 12 |
| TOTAL | | 80 | 99 |

OCCUPANCY

| SEAT COUNT | | OCCUPANCY: | |
|-------------------------------------|--------------------------|---------------|------------|
| RESTAURANT (INTERIOR) (EXTERIOR) | 320 144 | ASSEMBLY: | 196 |
| | | KITCHEN: | 57 |
| | | BAR: | 37 |
| | | FOOD COUNTER: | 32 |
| TOTAL: | 464 SEATS | TOTAL: | 322 |

A-02

HPB SUBMITTAL

1601 DREXEL AVE :: MIAMI BEACH, FL 33139

SITE DATA

12/15/2016 URBAN ROBOT © 2016

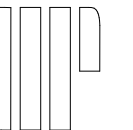

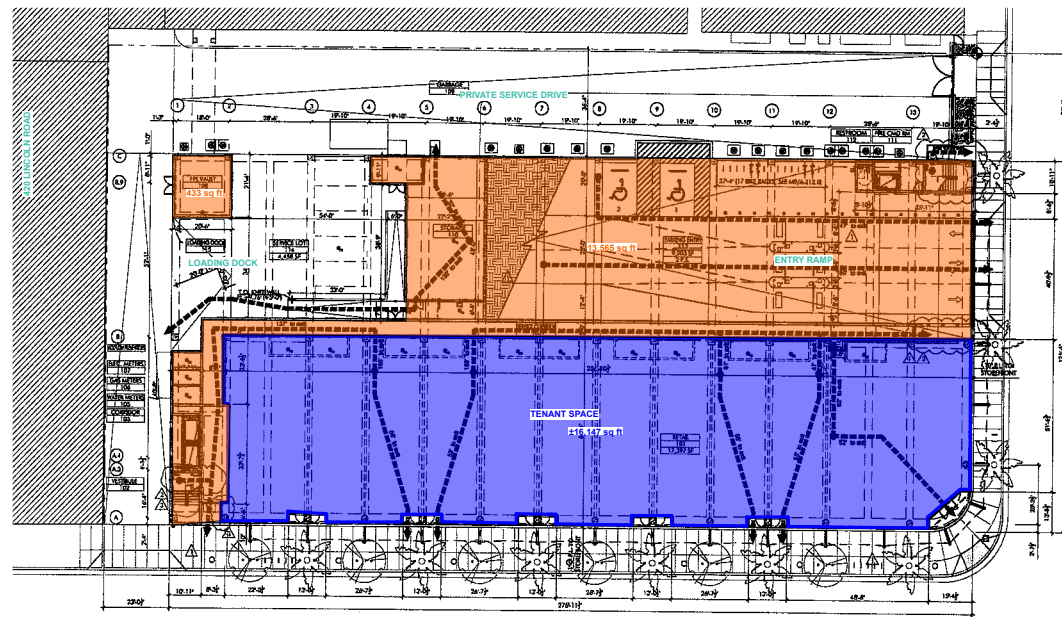

1 GROUND FLOOR

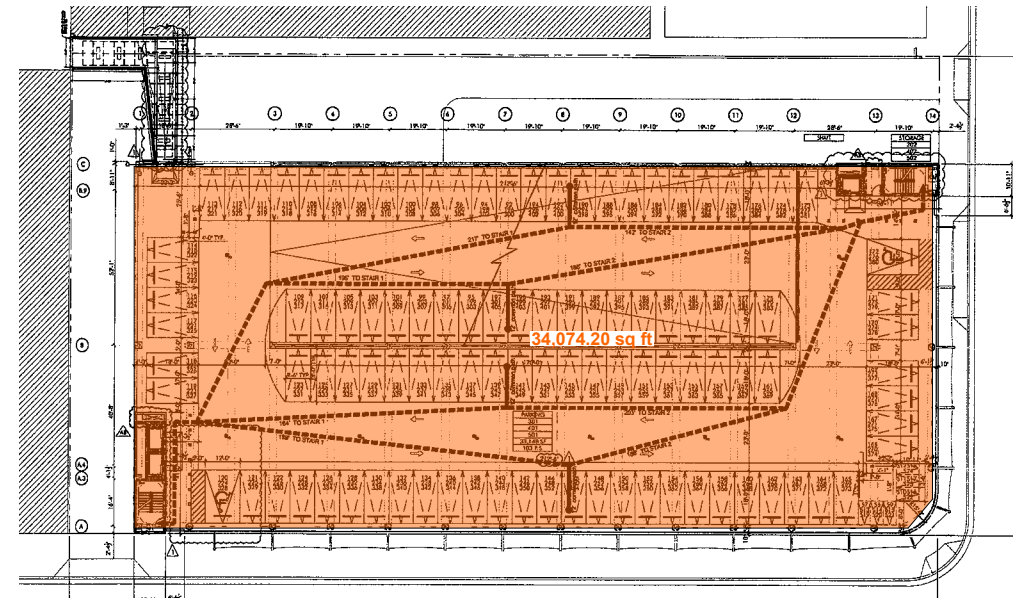

3 LEVEL 03, 04, & 05 PARKING

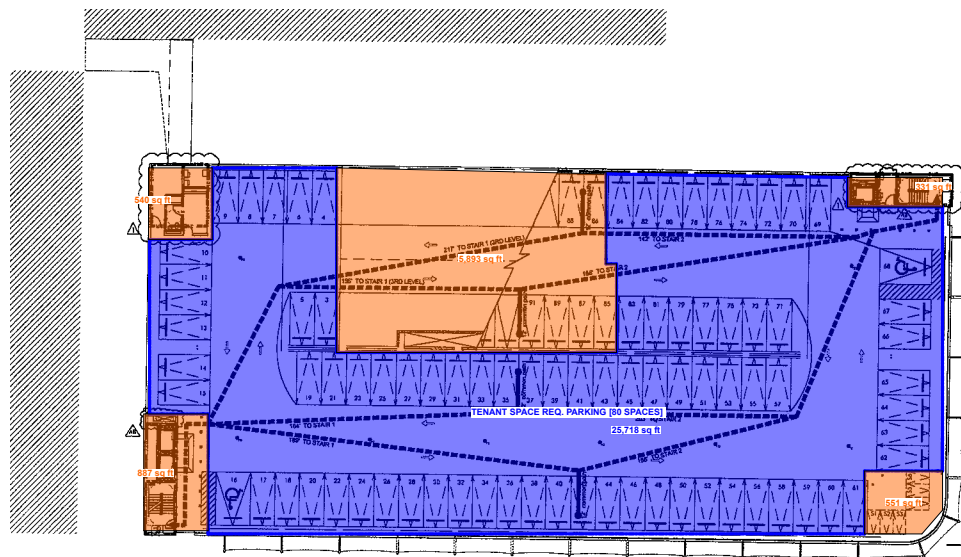

2 LEVEL 02 PARKING

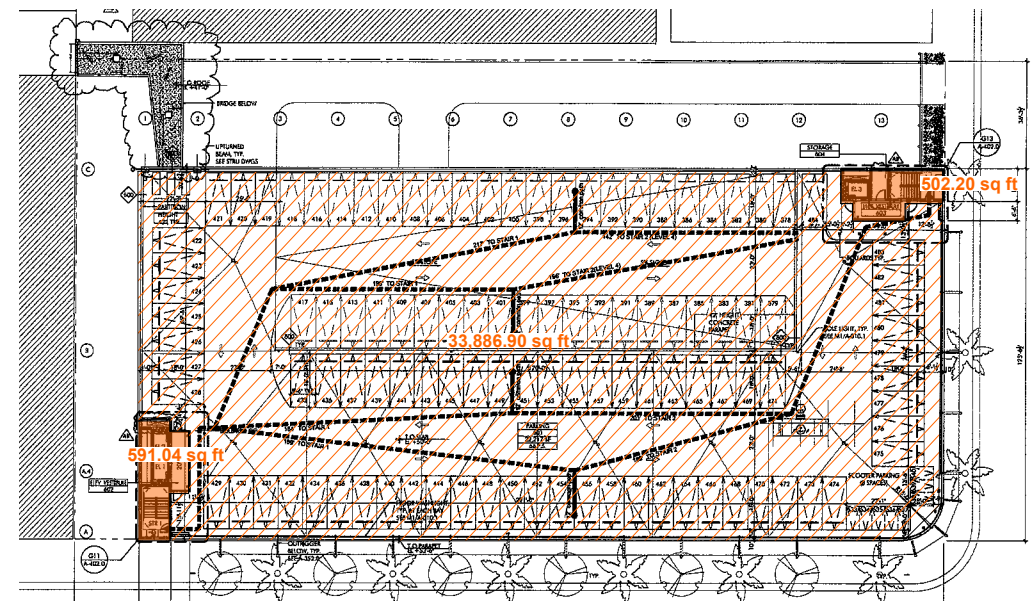

4 ROOF PARKING

| PROGRAM | GROUND LEVEL | LEVEL 02 | LEVEL 03 | LEVEL 04 | LEVEL 05 | ROOF | GFA TOTALS |
|--------------|--------------|-------------|-----------|-----------|-----------|-----------|---------------------------|
| TENANT SF | 16,147 SF | 25,718 SF** | - | - | - | - | 41,865 SF [25 %] |
| GARAGE SF | 13,998 SF | 8,202 SF | 34,074 SF | 34,074 SF | 34,074 SF | 1,093 SF | 125,515 SF [75 %] |
| ROOF PARKING | | | | | | 33,887 SF | |
| | | | | | | | 167,380 SF [100 %] |

** GARAGE SF FOR TENANT CALCULATED ON THE BASIS OF 464 RESTAURANT SEATS (320 INTERIOR SEATS & 144 EXTERIOR), & 1 PARKING SPACE PER 4 SEATS. [464/4= 116 PARKING SPACES]

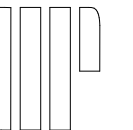



2.



1.



3.

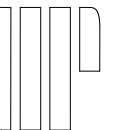
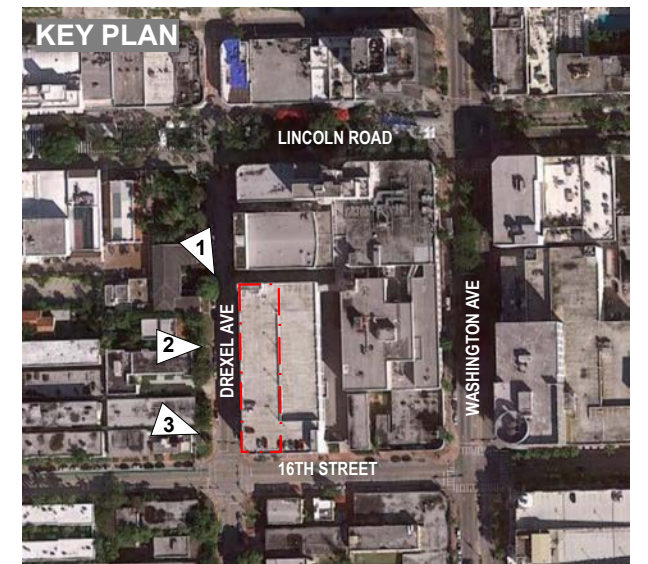



5.



4.



6.

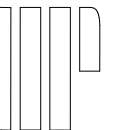
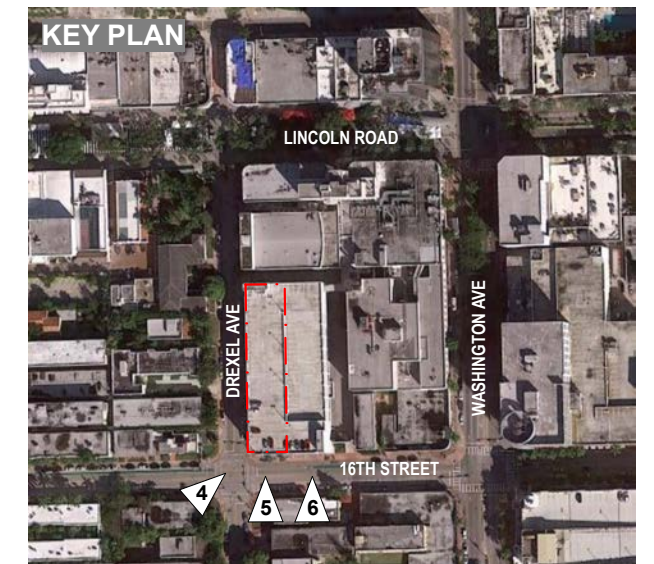



9.



8.



7.



12.



11.



10.

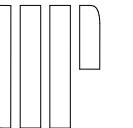
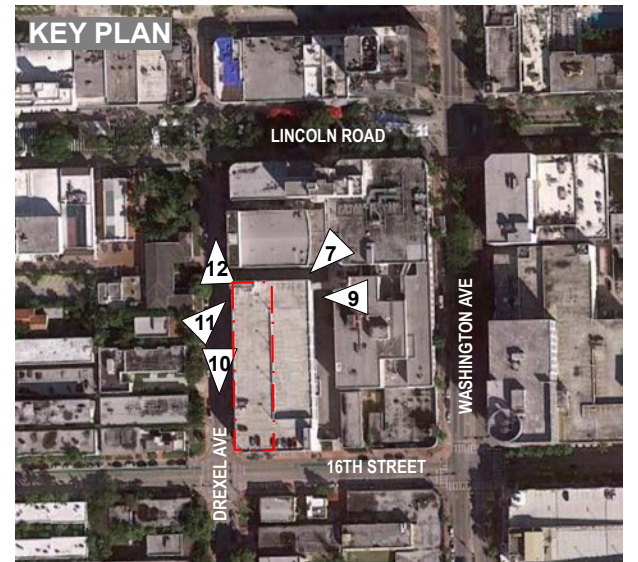



15.



14.



13.



17.



16.

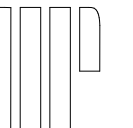
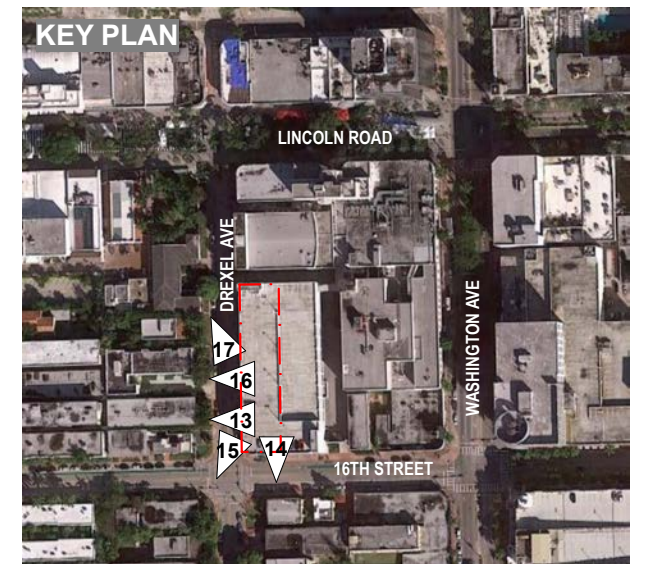



10-28-2016

1.



10-28-2016

2.

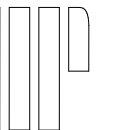



10-28-2016

5.



10-28-2016

4.



10-28-2016

3.

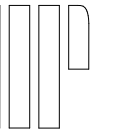

FOR REFERENCE ONLY

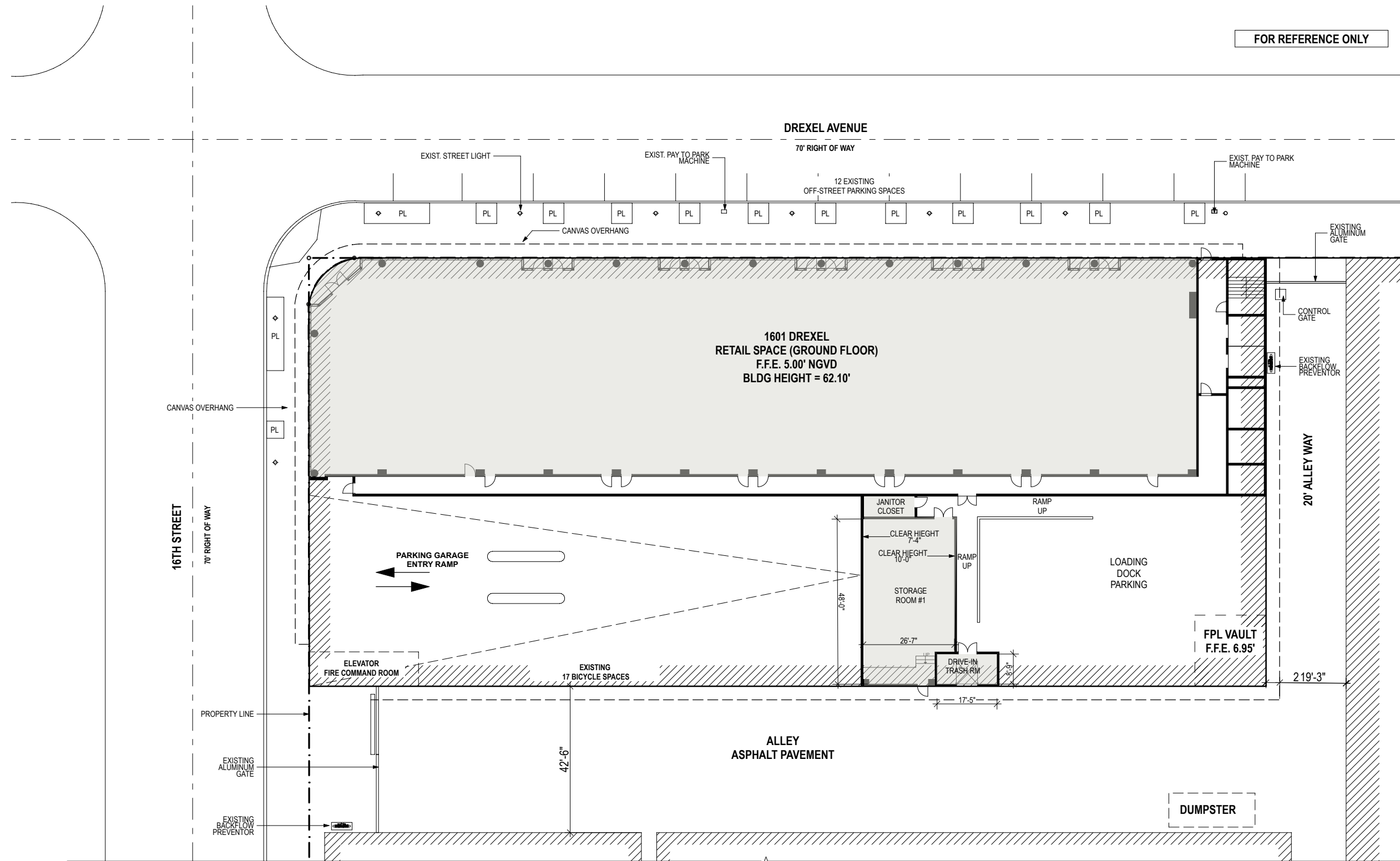

LEGEND

- TENANT SPACE IN SCOPE OF WORK
- PROPERTY LINE

EXISTING USE PLAN

SCALE: 1" = 30'

1



A-10

HPB SUBMITTAL

1601 DREXEL AVE :: MIAMI BEACH, FL 33139

EXISTING USE PLAN

12/15/2016 URBAN ROBOT © 2016

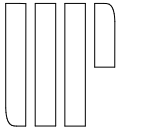

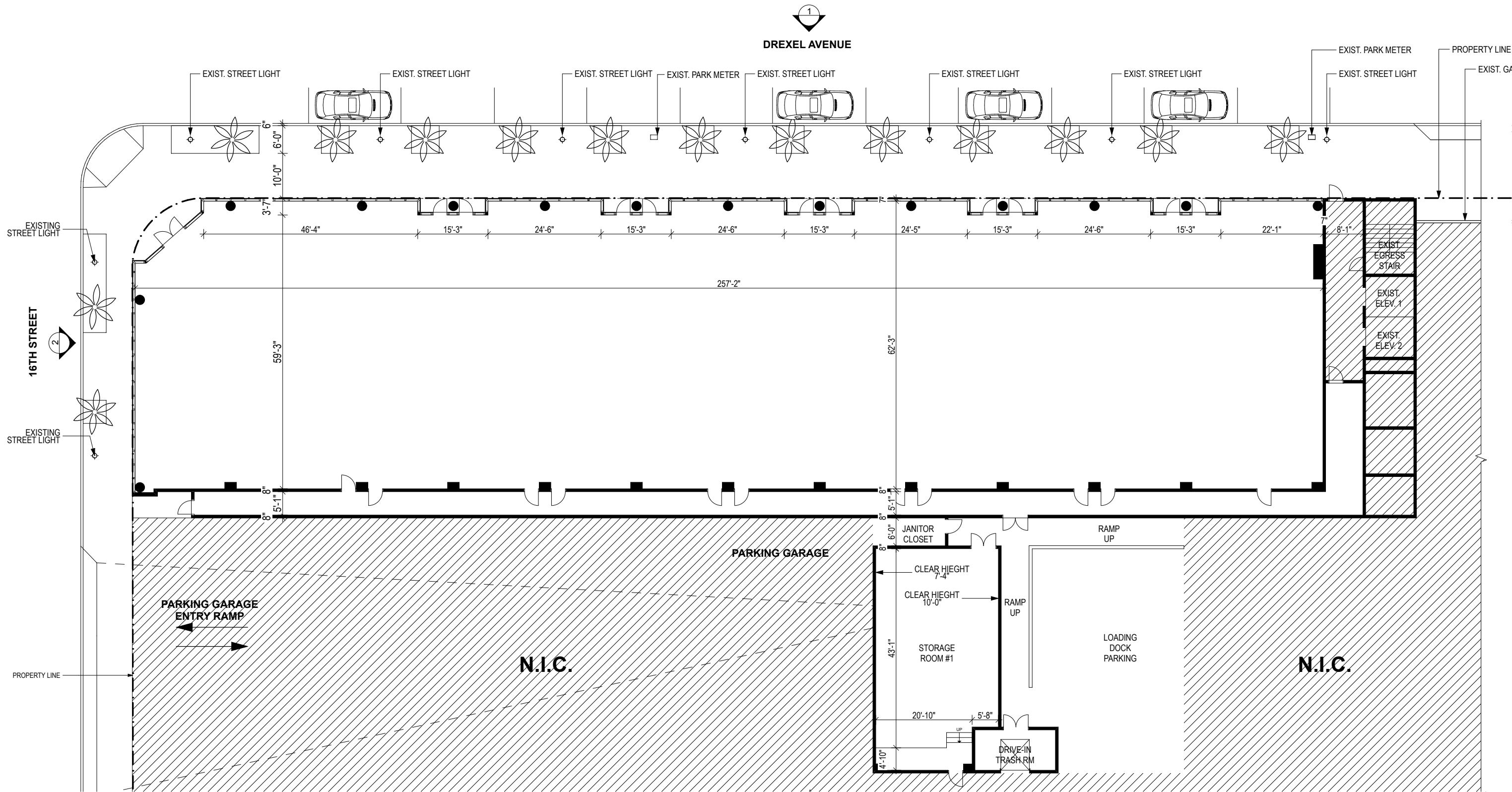

FOR REFERENCE ONLY

NOTE

1. LANDSCAPE IS NOT APPLICABLE. ALL EXISTING STREET LANDSCAPE MATERIAL, LIGHTING, IRRIGATION, CURBS, AS WELL AS UNDERGROUND AND OVER HEAD UTILITIES WILL REMAIN AS IS.

2. HARDSCAPE IS NOT APPLICABLE. ALL EXISTING PAVING MATERIAL WILL REMAIN AS IS.

1 EXISTING GROUND LEVEL
SCALE: 1" = 20'

A-11 | H P B S U B M I T T A L

1601 DREXEL AVE :: MIAMI BEACH, FL 33139

12 / 15 / 2016 URBAN ROBOT © 2016

EXISTING GROUND LEVEL PLAN

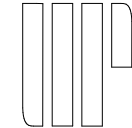

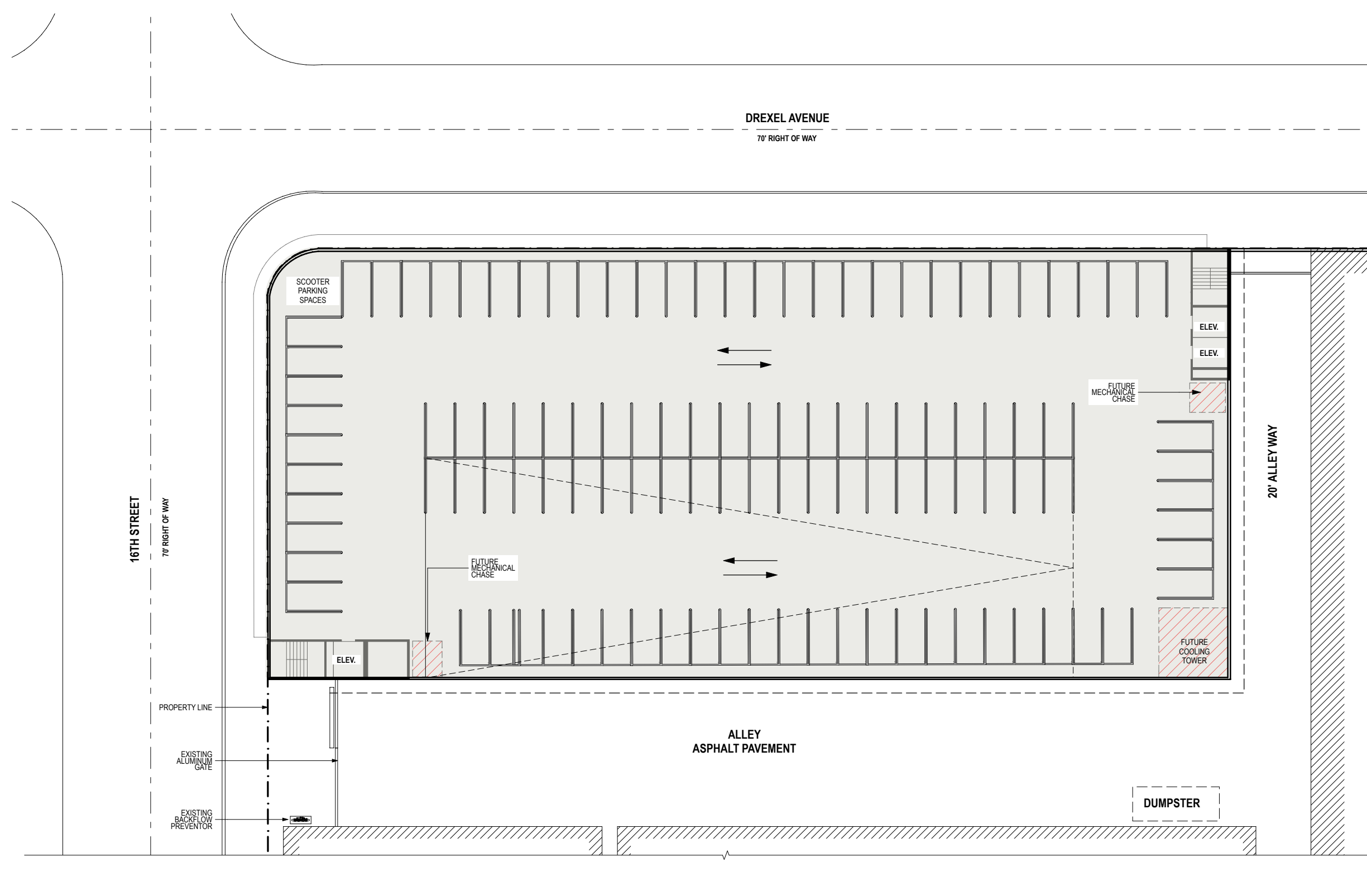

EXISTING ROOF PLAN

1

NOT TO SCALE

A-12

HPB SUBMITTAL

1601 DREXEL AVE :: MIAMI BEACH, FL 33139

EXISTING ROOF PLAN

12/15/2016 URBAN ROBOT © 2016



DREXEL AVENUE

16TH STREET

20' ALLEY WAY

1601 DREXEL
RETAIL SPACE (GROUND FLOOR)
F.F.E. 5.00' NGVD
BLDG HEIGHT = 62.10'

PARKING GARAGE
ENTRY

PARKING GARAGE

ELEVATOR
FIRE COMMAND ROOM

EXISTING
17 BICYCLE SPACES

JANITOR
CLOSET

CLEAR HIEGHT
7'-4"

CLEAR HIEGHT
10'-0"

STORAGE
ROOM

DRIVE-IN
TRASH RM

RAMP
UP

LOADING
DOCK
PARKING

LOADING
DOCK
PARKING

FPL VAULT
F.F.E. 6.95'

DEMOLITION KEY

- 1 DEMOLITION OF EXISTING STOREFRONT
- 2 REMOVAL OF EXISTING CANVAS OVERHANG

LEGEND

- TENANT SPACE IN SCOPE OF WORK
- PROPERTY LINE

1 DEMOLITION PLAN
SCALE: 1" = 20'

A-13

HPB SUBMITTAL

1601 DREXEL AVE :: MIAMI BEACH, FL 33139

DEMOLITION PLAN

12 / 15 / 2016 URBAN ROBOT © 2016

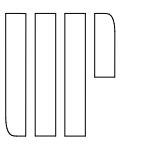

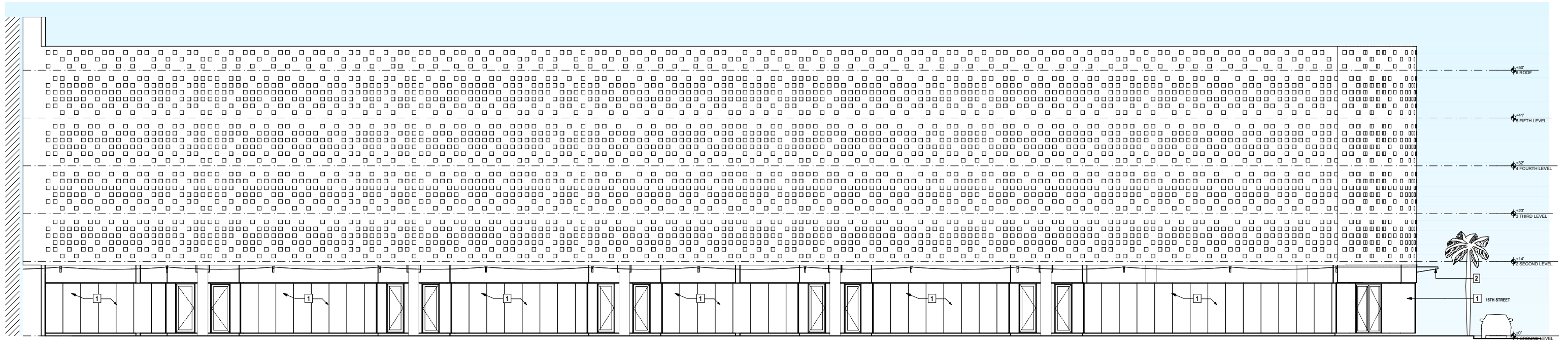

EXISTING/DEMO WEST ELEVATION

1

NOT TO SCALE

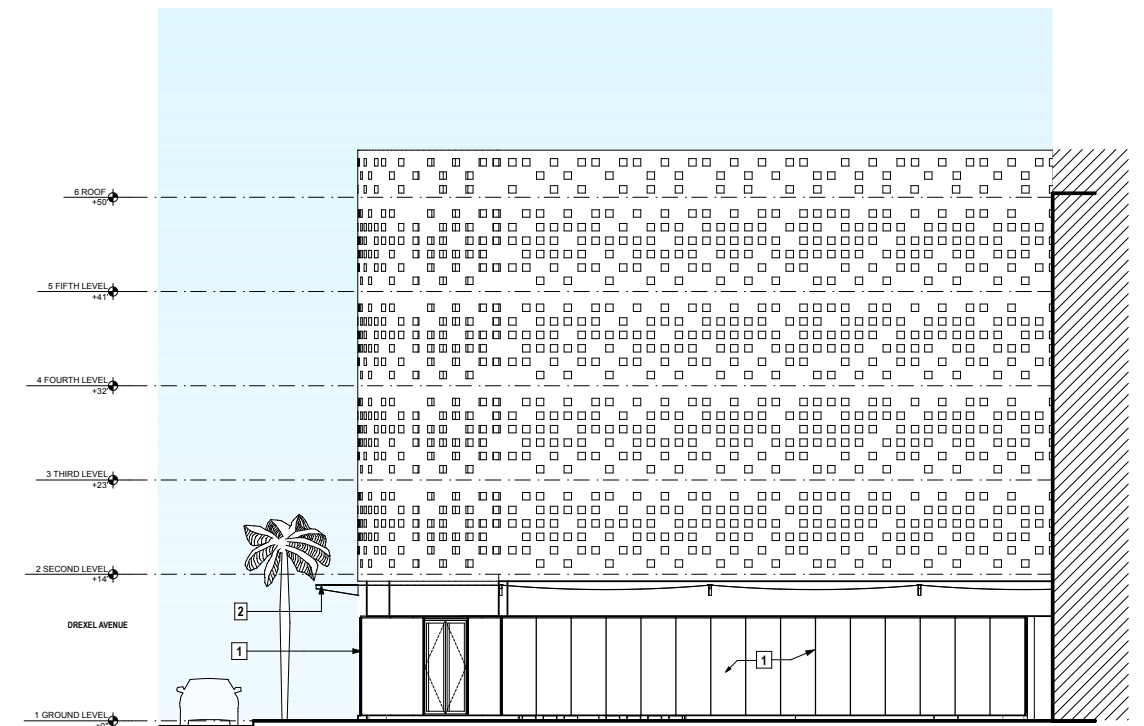

EXISTING/DEMO SOUTH ELEVATION

2

NOT TO SCALE

DEMOLITION KEY

- 1 DEMOLITION OF EXISTING STOREFRONT
- 2 REMOVAL OF EXISTING CANVAS OVERHANG

